



Republic of the Philippines
CITY GOVERNMENT OF SAN CARLOS
Province of Negros Occidental



**BIDS AND AWARDS COMMITTEE
(BAC)**

BIDDING DOCUMENTS

FOR

PURCHASE REQUEST NO. 18-24-11-2009

APPROVED BUDGET OF THE CONTRACT (ABC): P 5,140,600.00

**ROAD CONCRETING WITH DRAINAGE INSIDE AGRICULTURE COMPOUND (PHASE 1),
BRGY. RIZAL, SAN CARLOS CITY, NEGROS OCCIDENTAL**

WITH TERMS OF REFERENCE (TOR) & PROJECT PLAN

(First Envelope: Eligibility and Technical Components)

SUBMITTED BY : _____
ADDRESS : _____
CONTACT NO. : _____
EMAIL AD : _____

DATE OF SUBMISSION



Republic of the Philippines
CITY GOVERNMENT OF SAN CARLOS
Province of Negros Occidental

INSTRUCTIONS TO BIDDERS

1. Please submit sets of documents completely in two separate envelopes:
The *First Envelope (Original, Copy 1 and Copy 2)* containing Eligibility and Technical documents
The *Second Envelope (Original, Copy 1 and Copy 2)* containing Financial documents.
2. Check that all annexes are in accordance with the prescribed format and submit in chronological order.
3. Submit your completed bid documents on or before the time of the opening of bids mentioned below.
4. Electronic submission and receipt of bids is not available pending compliance with GPPB Resolutions.

Compliance of the above is for mutual advantage, i.e. to facilitate a complete and thorough evaluation of your bid documents.

SCHEDULES

Schedule/Place of Pre bid Conference

DECEMBER 17, 2024 @ 2:30 PM
BAC Secretariat Office
2F City Hall Building

Schedule/Place of Bid Opening

JANUARY 7, 2025 @ 1:30 PM
BAC Secretariat Office
2F City Hall Building

Nonrefundable fee of Bidding Documents = ₱ 10,000.00

Bid and Awards Committee
City of San Carlos



Republic of the Philippines
CITY GOVERNMENT OF SAN CARLOS
Province of Negros Occidental

Contract Name: ROAD CONCRETING WITH DRAINAGE INSIDE AGRICULTURE COMPOUND (PHASE 1), BRGY. RIZAL, SAN CARLOS CITY, NEGROS OCCIDENTAL

Location of the Contract: San Carlos City, Negros Occidental

CHECKLIST OF ELIGIBILITY AND TECHNICAL PROPOSALS/REQUIREMENTS

- 1. PHILGEPS (CERTIFICATE OF REGISTRATION AND MEMBERSHIP IN ACCORDANCE WITH SECTION 8.5.2 OF R.A 9184 – PLATINUM MEMBERSHIP**



Republic of the Philippines
CITY GOVERNMENT OF SAN CARLOS
Province of Negros Occidental

Contract Name: ROAD CONCRETING WITH DRAINAGE INSIDE AGRICULTURE COMPOUND (PHASE 1), BRGY. RIZAL, SAN CARLOS CITY, NEGROS OCCIDENTAL

Location of the Contract: San Carlos City, Negros Occidental

CHECKLIST OF ELIGIBILITY AND TECHNICAL PROPOSALS/REQUIREMENTS

2. JOINT VENTURE AGREEMENT (JVA), IF APPLICABLE



Republic of the Philippines
CITY GOVERNMENT OF SAN CARLOS
Province of Negros Occidental

Contract Name: ROAD CONCRETING WITH DRAINAGE INSIDE AGRICULTURE COMPOUND (PHASE 1), BRGY. RIZAL, SAN CARLOS CITY, NEGROS OCCIDENTAL

Location of the Contract: San Carlos City, Negros Occidental

CHECKLIST OF ELIGIBILITY AND TECHNICAL PROPOSALS/REQUIREMENTS

- 3. NET FINANCIAL CONTRACTING CAPACITY (NFCC) BASED ON THE DATA SUBMITTED TO THE BIR THRU ITS EFPS OR COMMITTED LINE OF CREDIT (CLC) FROM A UNIVERSAL OR COMMERCIAL BANK**



Republic of the Philippines
CITY GOVERNMENT OF SAN CARLOS
Province of Negros Occidental

Contract Name: ROAD CONCRETING WITH DRAINAGE INSIDE AGRICULTURE COMPOUND (PHASE 1), BRGY. RIZAL, SAN CARLOS CITY, NEGROS OCCIDENTAL

Location of the Contract: San Carlos City, Negros Occidental

CHECKLIST OF ELIGIBILITY AND TECHNICAL PROPOSALS/REQUIREMENTS

4. DULY NOTARIZED STATEMENT OF ALL ON-GOING (GOVERNMENT AND PRIVATE) CONTRACTS.

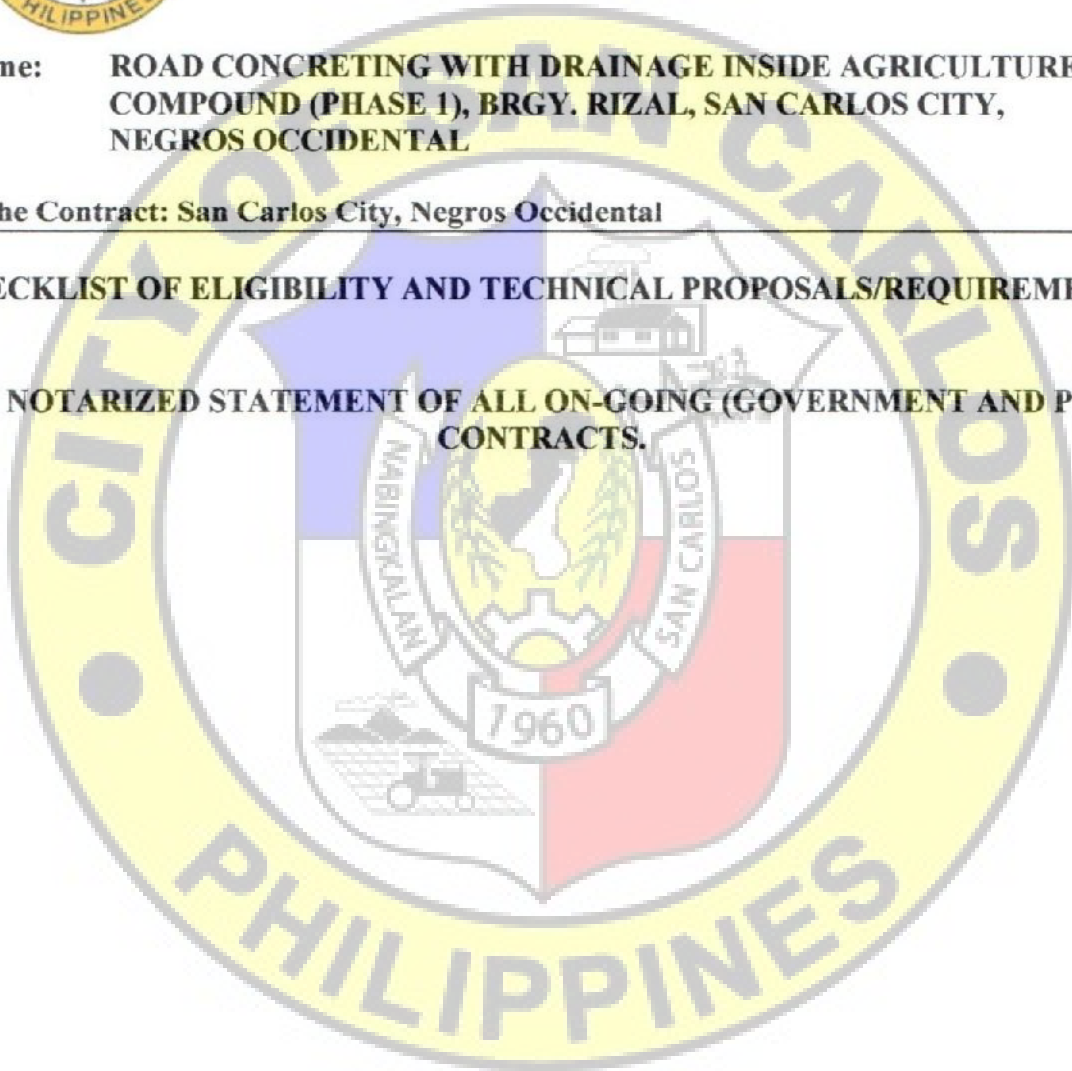



Republic of the Philippines
CITY GOVERNMENT OF SAN CARLOS
Province of Negros Occidental

Contract Name: ROAD CONCRETING WITH DRAINAGE INSIDE AGRICULTURE COMPOUND (PHASE 1), BRGY. RIZAL, SAN CARLOS CITY, NEGROS OCCIDENTAL

Location of the Contract: San Carlos City, Negros Occidental

CHECKLIST OF ELIGIBILITY AND TECHNICAL PROPOSALS/REQUIREMENTS

5. DULY NOTARIZED STATEMENTS OF:

- A. AT LEAST THREE (3) COMPLETED SIMILAR CONTRACTS (GOVERNMENT OR PRIVATE) FOR THE LAST FIVE (5) YEARS**
- B. SINGLE LARGEST COMPLETED CONTRACT (SLCC)- at least 50% OF THE TOTAL ABC**



Republic of the Philippines
CITY GOVERNMENT OF SAN CARLOS
Province of Negros Occidental

Contract Name: ROAD CONCRETING WITH DRAINAGE INSIDE AGRICULTURE COMPOUND (PHASE 1), BRGY. RIZAL, SAN CARLOS CITY, NEGROS OCCIDENTAL

Location of the Contract: San Carlos City, Negros Occidental

CHECKLIST OF ELIGIBILITY AND TECHNICAL PROPOSALS/REQUIREMENTS

6. PCAB LICENSE

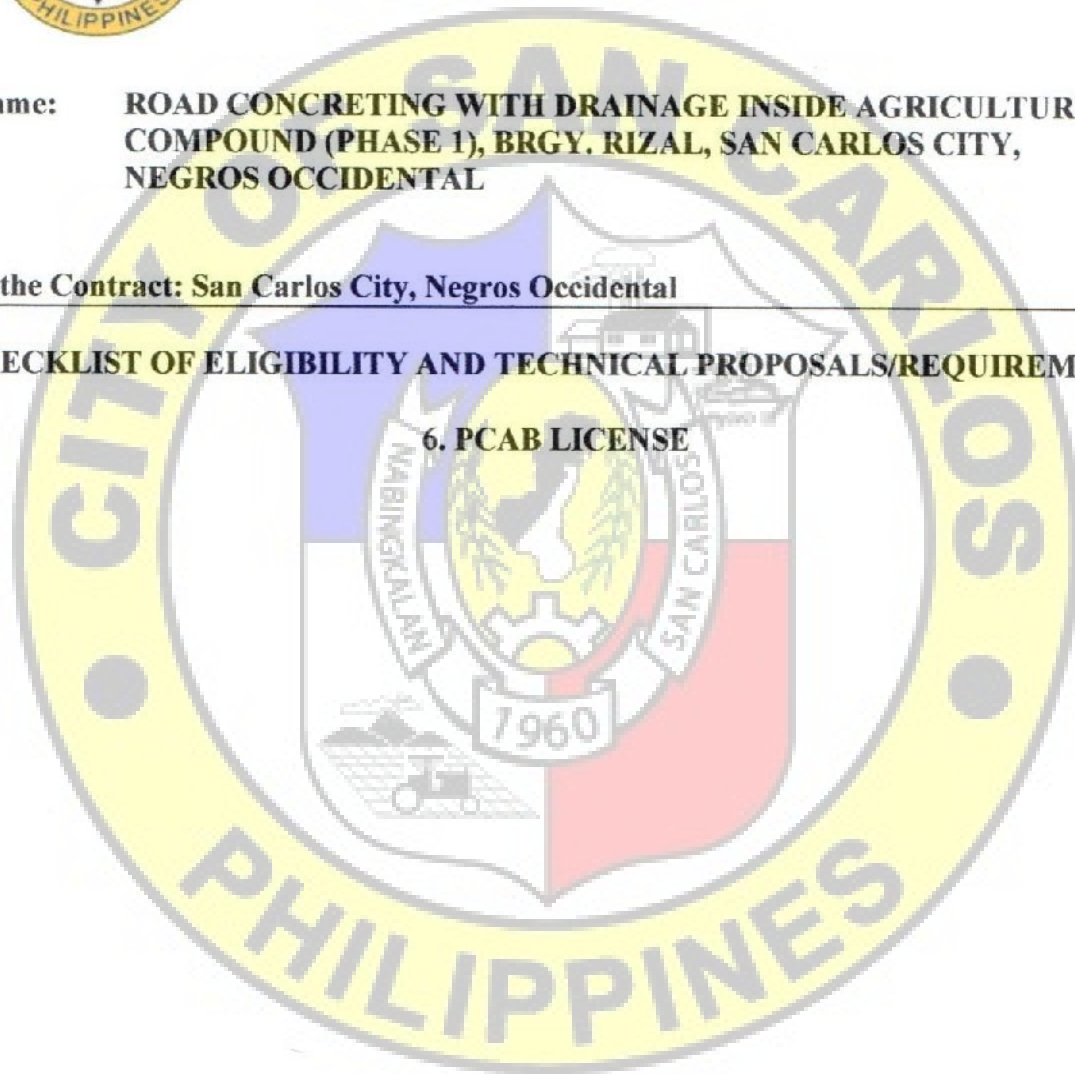



Contract Name: ROAD CONCRETING WITH DRAINAGE INSIDE AGRICULTURE COMPOUND (PHASE 1), BRGY. RIZAL, SAN CARLOS CITY, NEGROS OCCIDENTAL

Location of the Contract: San Carlos City, Negros Occidental

CHECKLIST OF ELIGIBILITY AND TECHNICAL PROPOSALS/REQUIREMENTS

7. PROJECT REQUIREMENTS

- a. Organizational Chart for the Contract to Bid
- b. List of Contractor's Personnel (Civil Engineer, Skilled and Manual Laborers), to be assigned to the contract to be bid, with their complete qualification and experience data
- c. List of contractor's equipment units which are owned, leased and/or under purchase agreements, supported by the certification of availability of equipment lessor/vendor for the duration of the project
- d. Duly notarized Affidavit of Site Inspection (Please see attached Form)

Name of the Procuring Entity

Contract Reference Number
Name of the Contract
Location of the Contract

Standard Form Number: SF-INR-51
Revised on: August 11,2004

AFFIDAVIT OF SITE INSPECTION

I, (Representative of the Bidder), of legal age, civil status, Filipino and residing at (Address of the Representative), under oath, hereby depose and say:

1. That I am the (Position of the Bidder) of the (Name of the Bidder), with office at (Address of the Bidder);
2. That I have inspected the site for (Name of Contract), located at (Location of the Contract);
3. That I am making this stamen as part of the requirement for the Technical Proposal of the (Name of the Bidder) for (Name of the Contract).

IN FAITH WHEREOF, I hereby affix my signature this _____ day of _____, 20____ at _____, Philippines.

AFFIANT

SUBSCRIBED AND SWORN TO before me this _____ day of _____, 20____, affiant exhibiting to me his/ her Community Tax Certificate No. _____ issued on _____ at _____, Philippines.

(Notary Public)

Until _____
PTR No. _____
Date _____
Place _____
TIN _____

Document No. _____
Page No. _____
Book No. _____
Series of _____



Republic of the Philippines
CITY GOVERNMENT OF SAN CARLOS
 Province of Negros Occidental

Contract Name: ROAD CONCRETING WITH DRAINAGE INSIDE AGRICULTURE COMPOUND (PHASE 1), BRGY. RIZAL, SAN CARLOS CITY, NEGROS OCCIDENTAL

Location of the Contract: San Carlos City, Negros Occidental

CHECKLIST OF ELIGIBILITY AND TECHNICAL PROPOSALS/REQUIREMENTS

8. BID SECURITY IN ANY OF THE FOLLOWING FORMS:

- a. Cash or Cashier's Check or Manager's Check issued by a Universal or Commercial Bank in favor of City Treasurer of San Carlos City (Two percent (2%) of the ABC)
- b. Bank draft/ guarantee or Irrevocable Letter of Credit issued by a Universal or Commercial Bank ; provided , however, that it shall be confirmed or authenticated by a Universal or Commercial Bank, if issued by a foreign bank, (Two percent (2%) of the ABC)
- c. Surety bond callable upon demand issued by a surety or insurance company duly certified by the Insurance commission as authorized to issue such authority;(Five percent (5%) of the ABC)
- d. Any combination of the foregoing (Proportionate to share form with respect to total amount of security)
- e. Bid Securing Declaration

REPUBLIC OF THE PHILIPPINES)
 CITY OF SAN CARLOS, NEGROS OCCIDENTAL) S.S.

BID SECURING DECLARATION

Project Identification No. / Purchase Request (PR) No. : 18-24-11-2009

To: *[Insert name and address of the Procuring Entity]*

I/ We, the undersigned, declare that:

1. I/ We understand that, according to your conditions, bids must be supported by a Bid Security, which may be in the form of a Bid Securing Declaration.
2. I/ We accept that: (a) I/ We will be automatically disqualified from bidding for any procurement contract with any procuring entity for a period of two (2) years upon receipt of your Blacklisting order; and 9b) I/ We will pay the applicable fine provided under Section 6 of the Guidelines on the Use of Bid Securing Declaration, within fifteen (15) days from receipt of the written demand by the procuring entity for the commission of acts resulting to the enforcement of the bid securing declaration under Section 23.1(b), 34.2, 40.1 and 69.1, except 69.1(f), of the IRR of RA No. 9184; without prejudice to other legal action the government may undertake.
3. I/ We understand that this Bid Securing Declaration shall cease to be valid on the following circumstances:
 - a. Upon expiration of the bid validity period, or any extension thereof pursuant to your request;
 - b. I am/ We are declared ineligible or post- disqualified upon receipt of your notice to such effect, and (i) I / We failed to timely file a request for reconsideration or (ii) I/ We filed a waiver to avail of said right; and
 - c. I am/ We are declared the bidder with the Lowest Calculated Responsive Bid, and I/ We have furnished the performance security and signed the Contract.

IN WITNESS THEREOF, I/ We have hereunto set my/ our hand/s this ____ day of *[month]* *[year]* at *[place of execution]*.

[Insert NAME OF BIDDER OR ITS AUTHORIZED REPRESENTATIVE]
[Insert signatory's legal capacity]

Affiant

[Jurat]

[Format shall be based on the latest Rules on Notarial Practice]



Republic of the Philippines
CITY GOVERNMENT OF SAN CARLOS
Province of Negros Occidental

Contract Name: ROAD CONCRETING WITH DRAINAGE INSIDE AGRICULTURE COMPOUND (PHASE 1), BRGY. RIZAL, SAN CARLOS CITY, NEGROS OCCIDENTAL

Location of the Contract: San Carlos City, Negros Occidental

CHECKLIST OF ELIGIBILITY AND TECHNICAL PROPOSALS/REQUIREMENTS

9. OMNIBUS SWORN STATEMENT IN ACCORDANCE WITH SEC. 25.3

Purchase Request (PR) No. 18-24-11-2009

REPUBLIC OF THE PHILIPPINES)
CITY OF SAN CARLOS, NEGROS OCCIDENTAL) S.S.

AFFIDAVIT

I, [Name of Affiant], of legal age, [Civil Status], [Nationality], and residing at [Address of Affiant], after having been duly sworn in accordance with law, do hereby depose and state that:

1. [Select one, delete the other:]

[If a sole proprietorship:] I am the sole proprietor or authorized representative of [Name of Bidder] with office address at [address of Bidder];

[If a partnership, corporation, cooperative, or joint venture:] I am the duly authorized and designated representative of [Name of Bidder] with office address at [address of Bidder];

2. [Select one, delete the other:]

[If a sole proprietorship:] As the owner and sole proprietor, or authorized representative of [Name of Bidder], I have full power and authority to do, execute and perform any and all acts necessary to participate, submit the bid, and to sign and execute the ensuing contract for [Name of the Project] of the [Name of the Procuring Entity], as shown in the attached duly notarized Special Power of Attorney;

[If a partnership, corporation, cooperative, or joint venture:] I am granted full power and authority to do, execute and perform any and all acts necessary to participate, submit the bid, and to sign and execute the ensuing contract for [Name of the Project] of the [Name of the Procuring Entity], as shown in the attached [state title of attached document showing proof of authorization (e.g., duly notarized Secretary's Certificate, Board/Partnership Resolution, or Special Power of Attorney, whichever is applicable)];

3. [Name of Bidder] is not "blacklisted" or barred from bidding by the Government of the Philippines or any of its agencies, offices, corporations, or Local Government Units, foreign government/foreign or international financing institution whose blacklisting rules have been recognized by the Government Procurement Policy Board, **by itself or by relation, membership, association, affiliation, or controlling interest with another blacklisted person or entity as defined and provided for in the Uniform Guidelines on Blacklisting;**

4. Each of the documents submitted in satisfaction of the bidding requirements is an authentic copy of the original, complete, and all statements and information provided therein are true and correct;

5. [Name of Bidder] is authorizing the Head of the Procuring Entity or its duly authorized representative(s) to verify all the documents submitted;



Republic of the Philippines
CITY GOVERNMENT OF SAN CARLOS
Province of Negros Occidental

6. *[Select one, delete the rest:]*

[If a sole proprietorship:] The owner or sole proprietor is not related to the Head of the Procuring Entity, members of the Bids and Awards Committee (BAC), the Technical Working Group, and the BAC Secretariat, the head of the Project Management Office or the end-user unit, and the project consultants by consanguinity or affinity up to the third civil degree;

[If a partnership or cooperative:] None of the officers and members of *[Name of Bidder]* is related to the Head of the Procuring Entity, members of the Bids and Awards Committee (BAC), the Technical Working Group, and the BAC Secretariat, the head of the Project Management Office or the end-user unit, and the project consultants by consanguinity or affinity up to the third civil degree;

[If a corporation or joint venture:] None of the officers, directors, and controlling stockholders of *[Name of Bidder]* is related to the Head of the Procuring Entity, members of the Bids and Awards Committee (BAC), the Technical Working Group, and the BAC Secretariat, the head of the Project Management Office or the end-user unit, and the project consultants by consanguinity or affinity up to the third civil degree;

7. *[Name of Bidder]* complies with existing labor laws and standards; and

8. *[Name of Bidder]* is aware of and has undertaken the responsibilities as a Bidder in compliance with the Philippine Bidding Documents, which includes:

- a. Carefully examining all of the Bidding Documents;
- b. Acknowledging all conditions, local or otherwise, affecting the implementation of the Contract;
- c. Making an estimate of the facilities available and needed for the contract to be bid, if any; and
- d. Inquiring or securing Supplemental/Bid Bulletin(s) issued for the *[Name of the Project]*.

9. *[Name of Bidder]* did not give or pay directly or indirectly, any commission, amount, fee, or any form of consideration, pecuniary or otherwise, to any person or official, personnel or representative of the government in relation to any procurement project or activity.

10. **In case advance payment was made or given, failure to perform or deliver any of the obligations and undertakings in the contract shall be sufficient grounds to constitute criminal liability for Swindling (Estafa) or the commission of fraud with unfaithfulness or abuse of confidence through misappropriating or converting any payment received by a person or entity under an obligation involving the duty to deliver certain goods or services, to the prejudice of the public and the government of the Philippines pursuant to Article 315 of Act No. 3815 s. 1930, as amended, or the Revised Penal Code.**

IN WITNESS WHEREOF, I have hereunto set my hand this ___ day of ___, 20__ at _____, Philippines.

[Insert NAME OF BIDDER OR ITS AUTHORIZED REPRESENTATIVE]

[Insert signatory's legal capacity]

Affiant

[Jurat]

[Format shall be based on the latest Rules on Notarial Practice]



Republic of the Philippines
CITY GOVERNMENT OF SAN CARLOS
Province of Negros Occidental

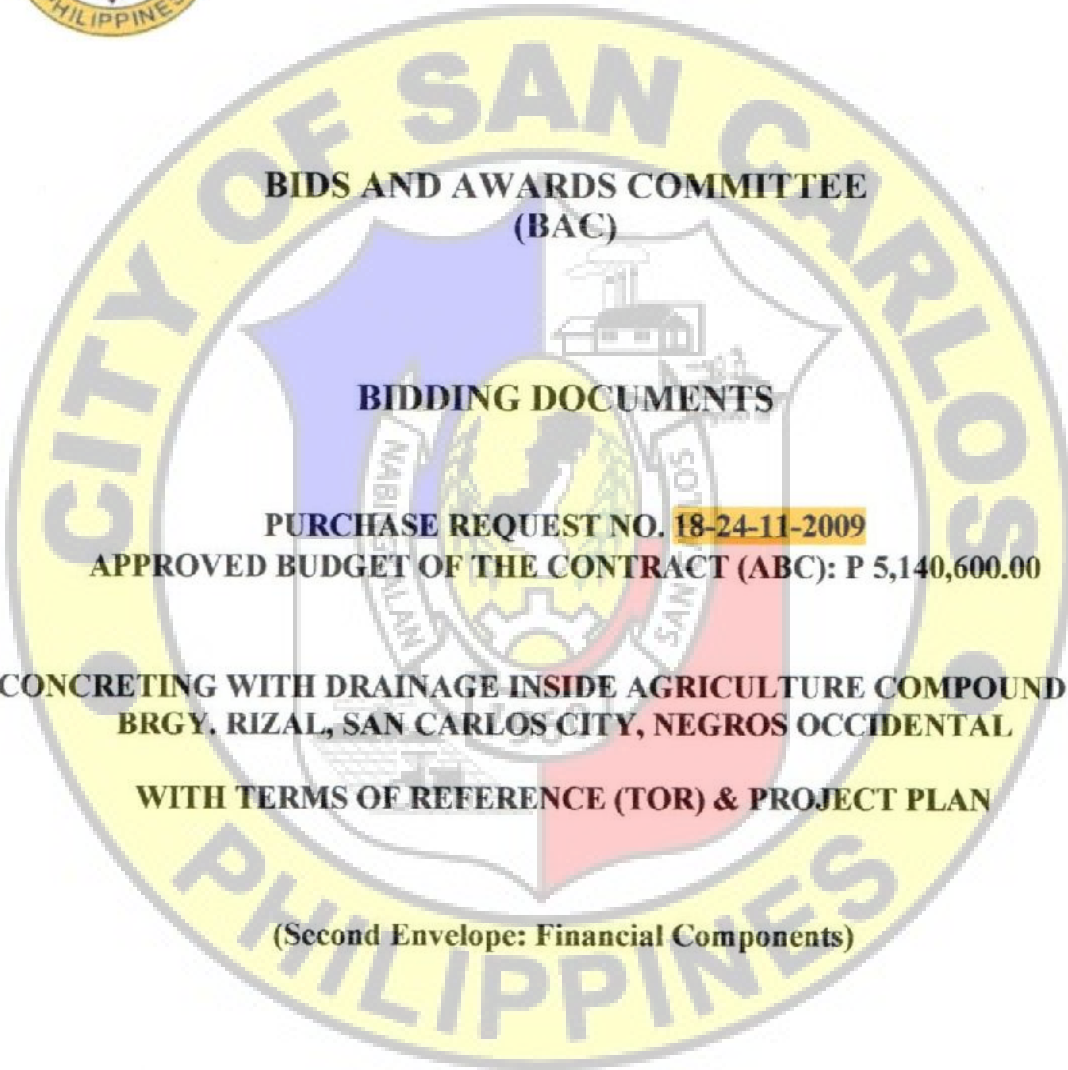

SUBMITTED BY : _____
ADDRESS : _____
CONTACT NO. : _____
EMAIL AD : _____

DATE OF SUBMISSION



Republic of the Philippines
CITY GOVERNMENT OF SAN CARLOS
Province of Negros Occidental

INSTRUCTIONS TO BIDDERS

1. Please submit sets of documents completely in two separate envelopes:
The *First Envelope (Original, Copy 1 and Copy 2)* containing Eligibility and Technical documents
The *Second Envelope (Original, Copy 1 and Copy 2)* containing Financial documents.
2. Check that all annexes are in accordance with the prescribed format and submit in chronological order.
3. Submit your completed bid documents on or before the time of the opening of bids mentioned below.
4. Electronic submission and receipt of bids is not available pending compliance with GPPB Resolutions.

Compliance of the above is for mutual advantage, i.e. to facilitate a complete and thorough evaluation of your bid documents.

SCHEDULES

Schedule/Place of Pre bid Conference

DECEMBER 17, 2024 @ 2:30 PM
BAC Secretariat Office
2F City Hall Building

Schedule/Place of Bid Opening

JANUARY 7, 2025 @ 1:30 PM
BAC Secretariat Office
2F City Hall Building

Nonrefundable fee of Bidding Documents = ₱ 10,000.00

Bid and Awards Committee
City of San Carlos



Republic of the Philippines
CITY GOVERNMENT OF SAN CARLOS
Province of Negros Occidental

Contract Name: ROAD CONCRETING WITH DRAINAGE INSIDE AGRICULTURE COMPOUND (PHASE 1), BRGY. RIZAL, SAN CARLOS CITY, NEGROS OCCIDENTAL.

Location of the Contract: San Carlos City, Negros Occidental

DULY SIGNED FORM OF BID

Date: _____

Project Identification/ Purchase Request No.: 18-24-11-2009
To: [name and address of Procuring Entity]

Having examined the Philippine Bidding documents (PBDs) including the Supplemental or Bid Bulletin Numbers [insert numbers], the receipt of which is hereby duly acknowledged, we the undersigned, declare that:

- a. We have no reservation to the PBDs, including the Supplemental or Bid Bulletins, for the Procurement Project: [insert name of the contract];
- b. We offer to execute the Works for this Contract in accordance with the PBDs;
- c. The total price of our Bid in words and figures, excluding any discounts offered below is: [insert information];
- d. The discounts offered and the methodology for their application are: [insert information];
- e. The total bid price includes the cost of all taxes, such as, but not limited to: [specify the applicable taxes, e.g. (i) value added tax (VAT), (ii) income tax), (iii) local taxes, and (iv) other fiscal levies and duties], which are itemized herein and reflected in the detailed estimates,
- f. Our Bid shall be valid within a period stated in the PBDs and it shall remain binding upon us at any time before the expiration of that period;
- g. If our Bid is accepted, we commit to obtain a Performance Security in the amount of [insert percentage amount] percent of the Contract Price for the due performance of the Contract, or a Performance Securing Declaration in lieu of the allowable forms of Performance Security, subject to the terms and conditions of issued GPPB guidelines¹ for this purpose;
- h. We are not participating, as Bidders, in more than one Bid in this bidding process, other than alternative offers in accordance with the Bidding Documents;
- i. We understand that this Bid, together with your written acceptance thereof included in your notification of award, shall constitute a binding contract between us, until a formal Contract is prepared and executed; and
- j. We understand that you are not bound to accept the Lowest Evaluated Bid or any other Bid that you may receive.
- k. We likewise certify/ confirm that the undersigned, is duly authorized representative of the bidder, and granted full power and authority to do, execute and perform any all acts necessary to participate, submit the bid, and to sign and execute the ensuing contract for the [Name of the Project] of the [Name of the Procuring Entity].
- l. We acknowledge that failure to sign each and every page of this Bid Form, including the Bill of Quantities, shall be ground for the rejection of our bid.

Name: _____

In the Capacity of: _____

Signed: _____

Duly authorized to sign the Bid for and on behalf of: _____

Date: _____



Republic of the Philippines
CITY GOVERNMENT OF SAN CARLOS
 Province of Negros Occidental

Contract Name: ROAD CONCRETING WITH DRAINAGE INSIDE AGRICULTURE COMPOUND (PHASE 1), BRGY. RIZAL, SAN CARLOS CITY, NEGROS OCCIDENTAL

Location of the Contract: San Carlos City, Negros Occidental

DULY SIGNED BID PRICE IN THE BILL OF QUANTITIES (BOQ)

BILL OF QUANTITIES					
(Columns (1), (2) and (3) are to be filled up by the Procuring Entity)			(Columns (4) and (5) are to be filled up by the Bidder)		
	Description	Unit	Quantity	Unit Price (Pesos)	Amount (Pesos)
	(1)	(2)	(3)	(4)	(5)
I	MOBILIZATION	lot	1.0	In words: Pesos _____ In figures: PHP _____	In words: Pesos _____ In figures: PHP _____
II	SUBGRADE PREPARATION	Sq.m.	1800.00	In words: Pesos _____ In figures: PHP _____	In words: Pesos _____ In figures: PHP _____
III	BASE PREPARATION	Cu.m.	360.00	In words: Pesos _____ In figures: PHP _____	In words: Pesos _____ In figures: PHP _____
IV	PORTLAND CEMENT CONCRETE PAVEMENT (PCCP)	cu.m.	360.00	In words: Pesos _____ In figures: PHP _____	In words: Pesos _____ In figures: PHP _____
V	DRAINAGE STRUCTURE	Lin.m	450.00	In words: Pesos _____ In figures: PHP _____	In words: Pesos _____ In figures: PHP _____
VII	DEMOBILIZATION	Lot	1.0	In words: Pesos _____ In figures: PHP _____	In words: Pesos _____ In figures: PHP _____
TOTAL BID COST					In words: PHP _____ In figures: PHP _____
					In figures: PHP _____ _____

Submitted by: _____

Date: _____

Name of the Representative of the Bidder

Position

Name of the Bidder Company



Republic of the Philippines
CITY GOVERNMENT OF SAN CARLOS
Province of Negros Occidental

Contract Name: ROAD CONCRETING WITH DRAINAGE INSIDE AGRICULTURE COMPOUND (PHASE 1), BRGY. RIZAL, SAN CARLOS CITY, NEGROS OCCIDENTAL

Location of the Contract: San Carlos City, Negros Occidental

DULY SIGNED DETAILED ESTIMATES

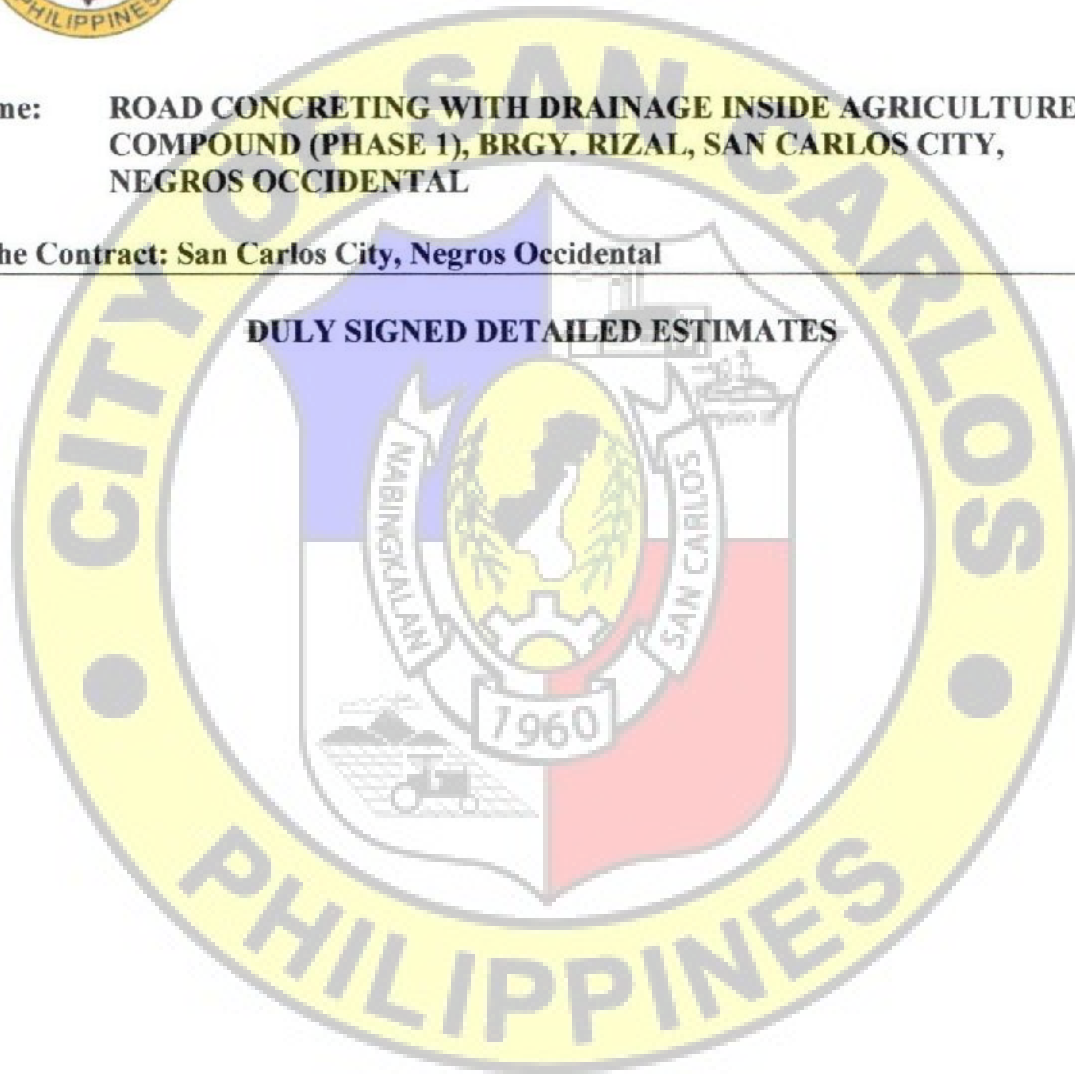



Republic of the Philippines
CITY GOVERNMENT OF SAN CARLOS
Province of Negros Occidental

Contract Name: ROAD CONCRETING WITH DRAINAGE INSIDE AGRICULTURE COMPOUND (PHASE 1), BRGY. RIZAL, SAN CARLOS CITY, NEGROS OCCIDENTAL

Location of the Contract: San Carlos City, Negros Occidental

DULY SIGNED CASH FLOW BY QUARTER AND PAYMENT SCHEDULE

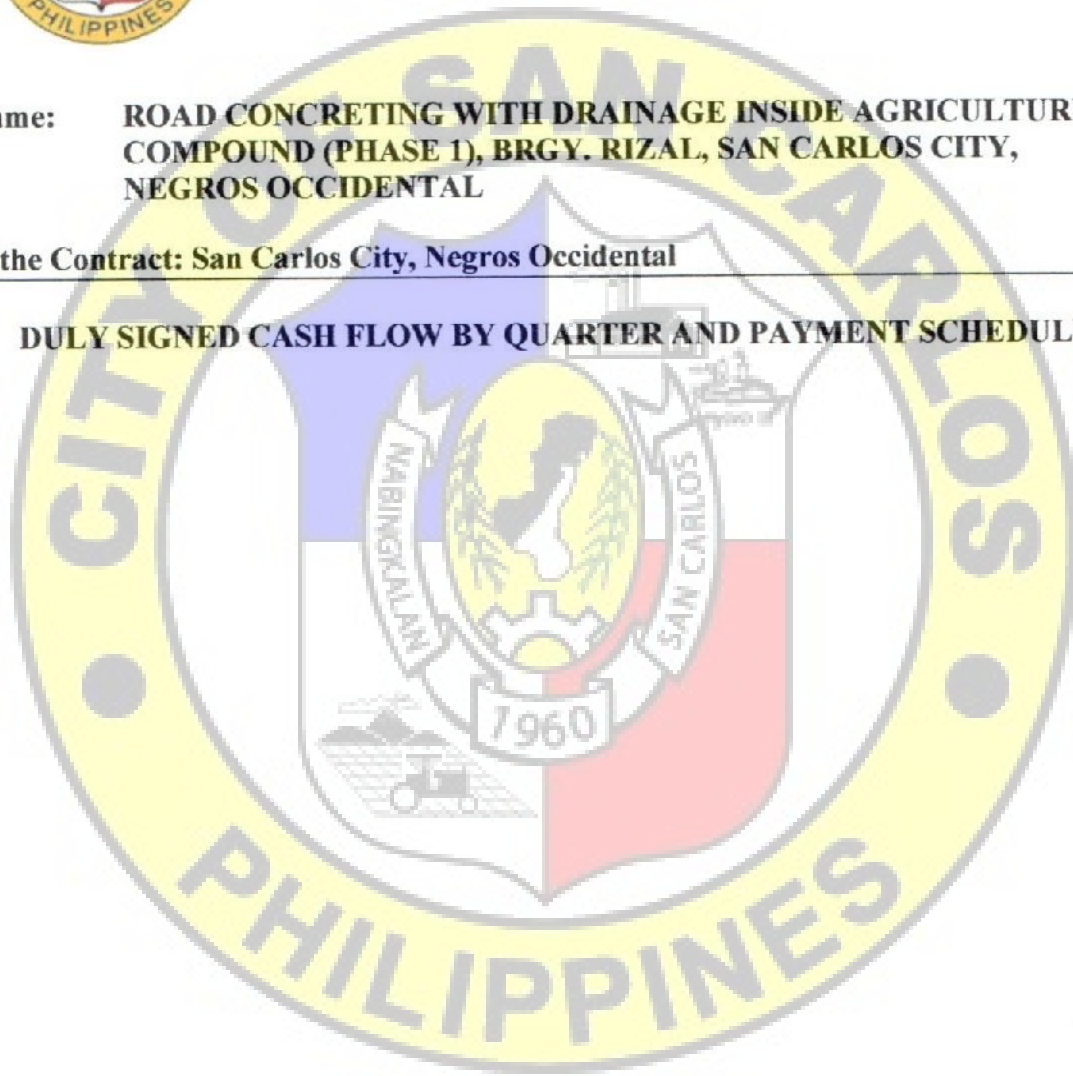

APPROVAL PAGE

**ROAD CONCRETING WITH DRAINAGE INSIDE AGRICULTURE COMPOUND
(PHASE 1)**

(P 5,140,600.00)

TERMS OF REFERENCE

Prepared:

JOHN LEUR C. VIRTUCIO
Engineer I

Reviewed:

REXTER E. NEMENZO
CGDH I (City Engineer)

Approved:

RENATO Y. GUSTILO
City Mayor

Republic of the Philippines

City of San Carlos

Province of Negros Occidental

CITY ENGINEERING DEPARTMENT

TERMS OF REFERENCE

**ROAD CONCRETING WITH DRAINAGE INSIDE AGRICULTURE COMPOUND
(PHASE 1)**

(P 5,140,600.00)

TABLE OF CONTENTS

A. Background	4
B. General Objective	4
C. The Bidder/Contractor	4
D. The Requirements	4
E. Delivery/Completion	5
F. Warranty	5
G. Payment Scheme	5



A. Background

The City government of San Carlos through the City Engineering Department proposed a road concreting with drainage inside Agriculture compound for more sustainable solution, leading to cleaner air and a healthier environment.

B. General Objectives

The primary objective of this project is to provide a Concrete Road with drainage.

C. The Bidder / Contractor

The bidder should have an experience in any Road Concreting Projects.

D. The Requirements

1. CONCRETE POURING PERMIT (CPR)

1.1. A Concrete Pouring Permit must be submitted to the Project Engineer every base course prepared for pouring. CPR must be inspected by the MQC and approved by the Project Engineer before the concrete pouring can proceed.

2. FIELD DENSITY TEST (FDT)

2.1. A Field Density Test is conducted by the MQC upon the official request of the Project Engineer thru the Concrete Pouring Permit. FDT must passed the minimum requirements in accordance to the standards and specifications stated in the DPWH Blue Book 2015.

3. TESTING OF CONSTRUCTION MATERIALS

3.1. Samples of coarse aggregates (75 kg), fine aggregates (50 kg), base course (25 kg) and rebars (3 pcs of 1-meter sample for every diameter) must be submitted to the MQC Laboratory for testing.

3.2. The Contractor must prepare their own concrete cylinder samples and must have an area secured enough to the hold the samples at its curing stage for 28 days without moving or disturbing the samples.

4. REQUIRED COMPRESSIVE STRENGTH

4.1. The strength level of the concrete will be considered satisfactory if the averages of all sets of three (3) consecutive strength test results equal or exceed the specified strength f_c' and no individual strength test result is deficient by more than 15% of the specified strength f_c' .

5. TESTING FEES

5.1. Testing fees must all in expense of the Contractor.

7. FINISHING AND CURING

- 7.1. Curing compound must be immediately applied to the concrete after pouring.
- 7.2. Concrete spans must be cut within 6 to 12 hours after finishing the concrete with a depth of 2" and must be applied with an asphalt sealer after cutting.

8. PUNCHLISTING

- 8.1. Punch listing must be attended by the Contractor's Personnel, MQC and by the end user.

9. GENERAL REQUIREMENTS

- 9.1 All plans and specifications shall be provided by the end-user.
- 9.2 Construction safety and health protocols should be observed at all times by the contractor during the duration of the project.
- 9.3 Clean up of the construction site after the project shall be the responsibility of the contractor

E. Delivery / Completion

Delivery/completion shall be within 180 Calendar days.

F. Warranty

Warranty shall be for a period of one year from the turn-over of the completed whole project.

G. Payment Scheme

The city has allocated a budget of Five Million, One hundred Forty Thousand, Six hund Pesos (5,140,600.00 Php) of the said project. The winning bidder shall be paid in accordance with **R.A. 9184** and other relevant laws.



THE SITE



SITE DEVELOPMENT PLAN
SCALE NTS





VICINITY MAP
SCALE NTS

From the office of : CED Drafted by:	Project Title : ROAD CONCRETING WITH DRAINAGE INSIDE AGRICULTURE COMPOUND (PHASE I)	Prepared : ENGR. JOHN LEUR C. VITIRCIO ENGINEER - I	Checked : ENGR. RAYMOND L. CELESTE ENGINEER - IV	Recommended for Approval : ENGR. REXTER E. NIMENZO COEH I (CITY ENGINEER)	Approved as to Plans and Specifications : HON. RENATO Y. GUSTILO CITY MAYOR	Sheet No : 1 3
Location : BRGY. CODCOD, SAN CARLOS CITY, NEG. OCC.						



ROAD = 360 LENIAL METER, WIDTH : 5.00m THK. 0.20m
 DRAIN = 300 METERS
 RCPC 20 = 150 METERS

SITE DEVELOPMENT PLAN
 SCALE NTS

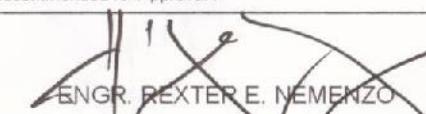
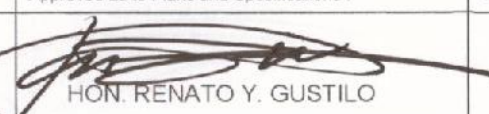
From the office of :	Project Title :	Prepared :	Checked :	Recommended for Approval :	Approved as to Plans and Specifications :	Sheet No :
CED	ROAD CONCRETING WITH DRAINAGE INSIDE AGRICULTURE COMPOUND (PHASE I)	 ENGR. JOHN LEUR C. VITIRCIO	 ENGR. RAYMOND L. CELESTE	 ENGR. REXTER E. NEMENZO	 HON. RENATO Y. GUSTILO	2 3
Drafted by :	Location : BRGY. CODCOD, SAN CARLOS CITY, NEG. OCC.	ENGINEER - I	ENGINEER - IV	CDCH I (CITY ENGINEER)	CITY MAYOR	

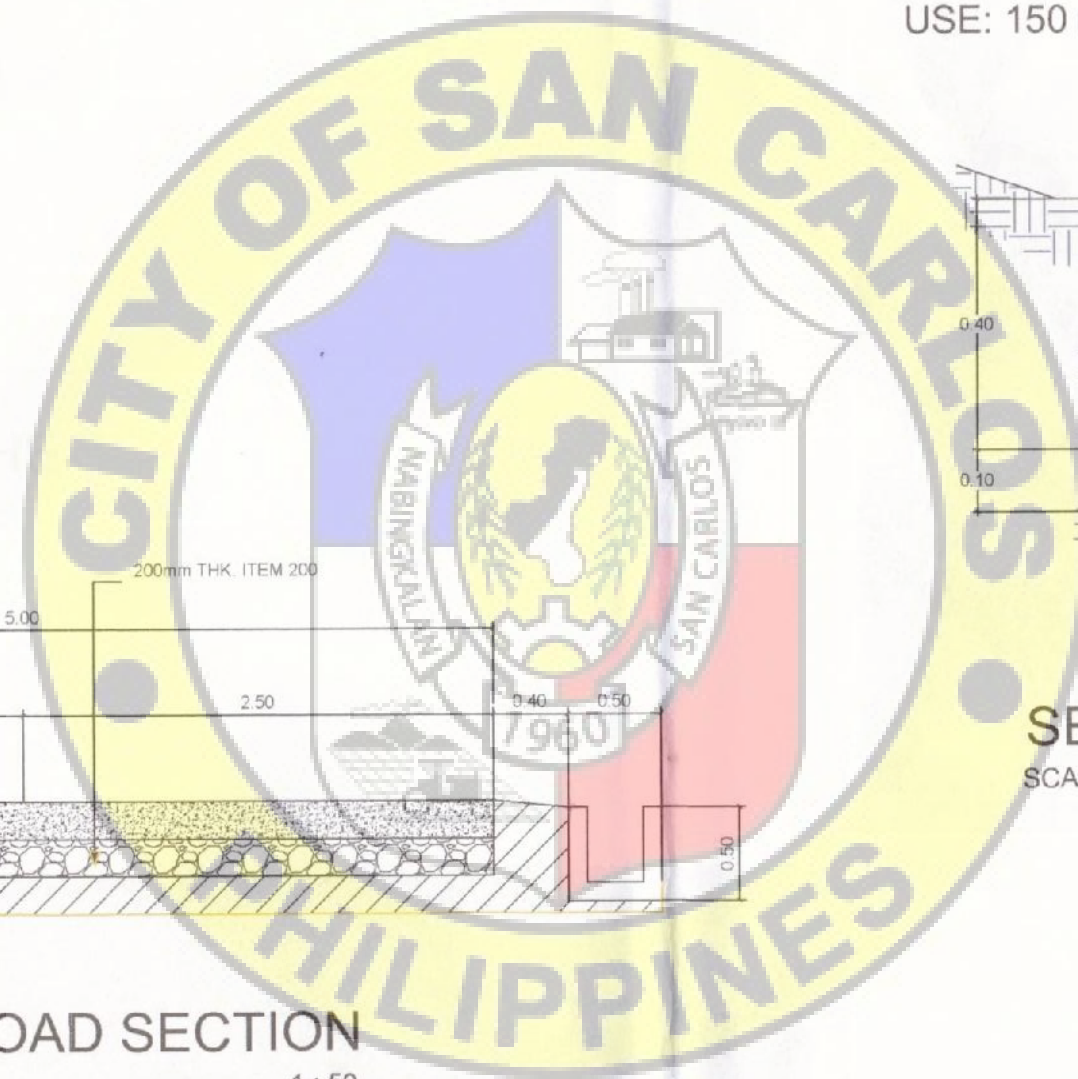

USE: 150 mm Ø - 220 mm Ø BOULDERS

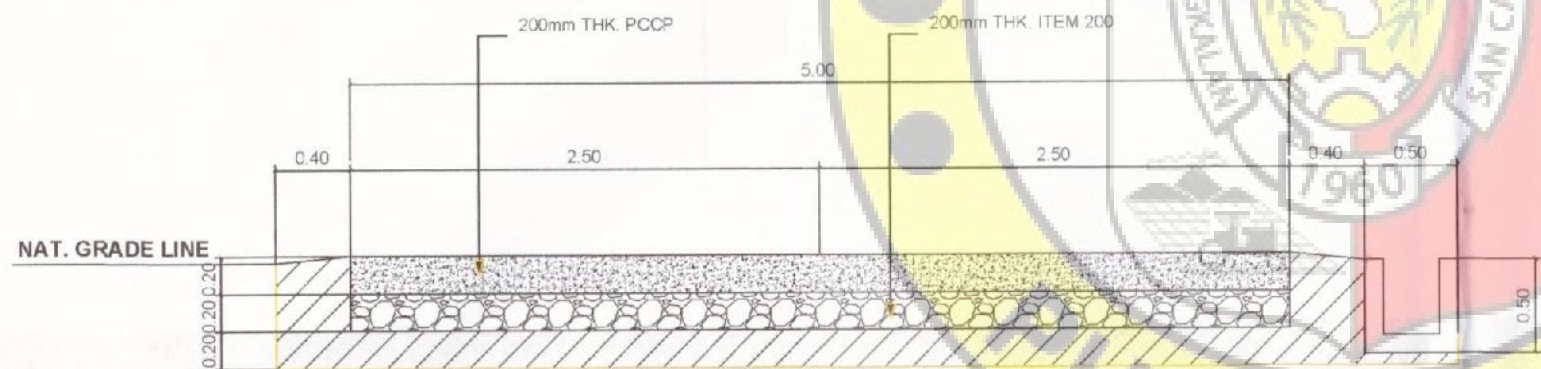

TYPICAL ROAD SECTION
SCALE 1 : 50

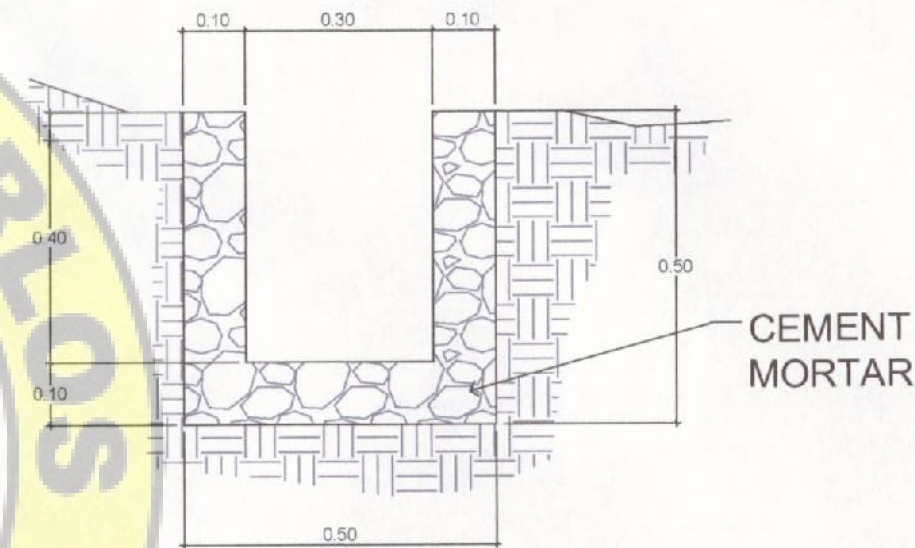

SECTION DETAILS
SCALE 1 : 25

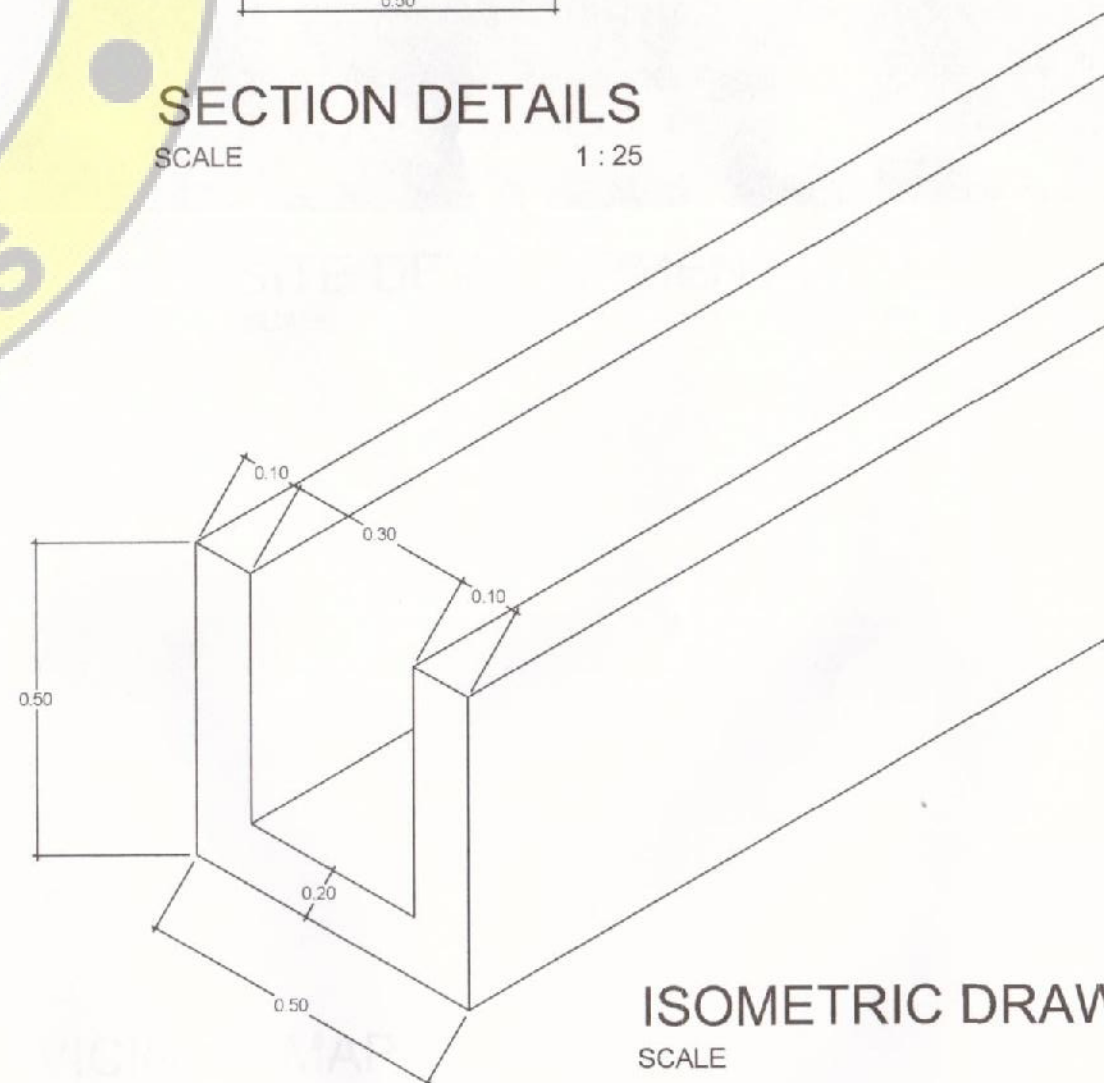

ISOMETRIC DRAWING
SCALE 1 : 25

From the office of : CED Drafted by	Project Title : ROAD CONCRETING WITH DRAINAGE INSIDE AGRICULTURE COMPOUND (PHASE I)	Prepared : ENGR. JOHN LEUR C. VITIRCIO ENGINEER - I	Checked : ENGR. RAYMOND L. CELESTE ENGINEER - IV	Recommended for Approval : ENGR. REXTER E. NEMENZO CEGH I (CITY ENGINEER)	Approved as to Plans and Specifications : HON. RENATO Y. GUSTILO CITY MAYOR	Sheet No : 3 3
Location : BRGY. CODCOD, SAN CARLOS CITY, NEG. OCC.						